

TONY

K 145

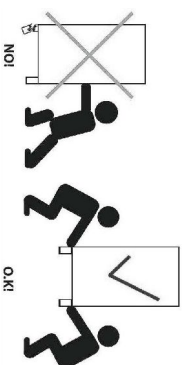
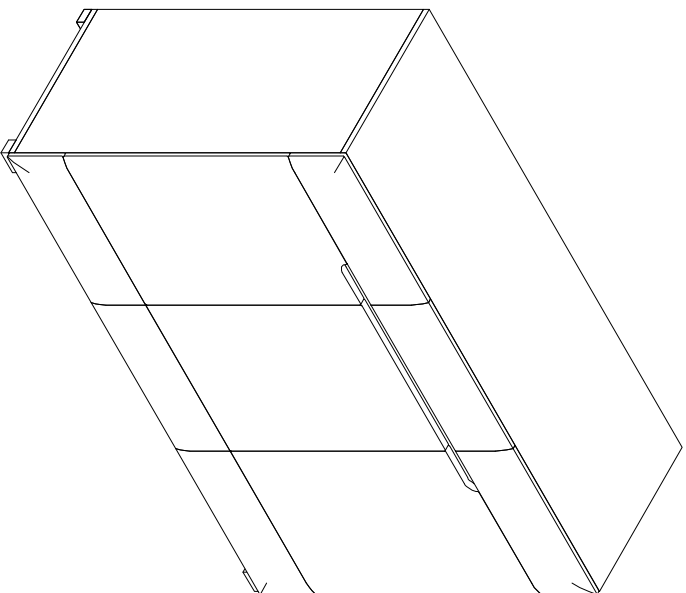

13.01.2016

- (D)** Montageanleitung
- (FR)** Notice de montage
- (NL)** Handleiding voor de montage
- (CZ)** Montážní návod
- (HU)** Szerelési útmutató
- (TR)** Montaj talimatı
- (GB)** Assembly Instructions
- (IT)** Istruzioni di montaggio
- (PL)** Instrukcja montażu
- (SK)** Návod na montáž
- (RO)** Instrucțiunile de montaj
- (RU)** Инструкции по монтажу

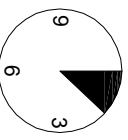
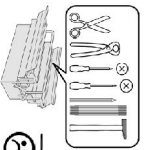

2-2,5

1

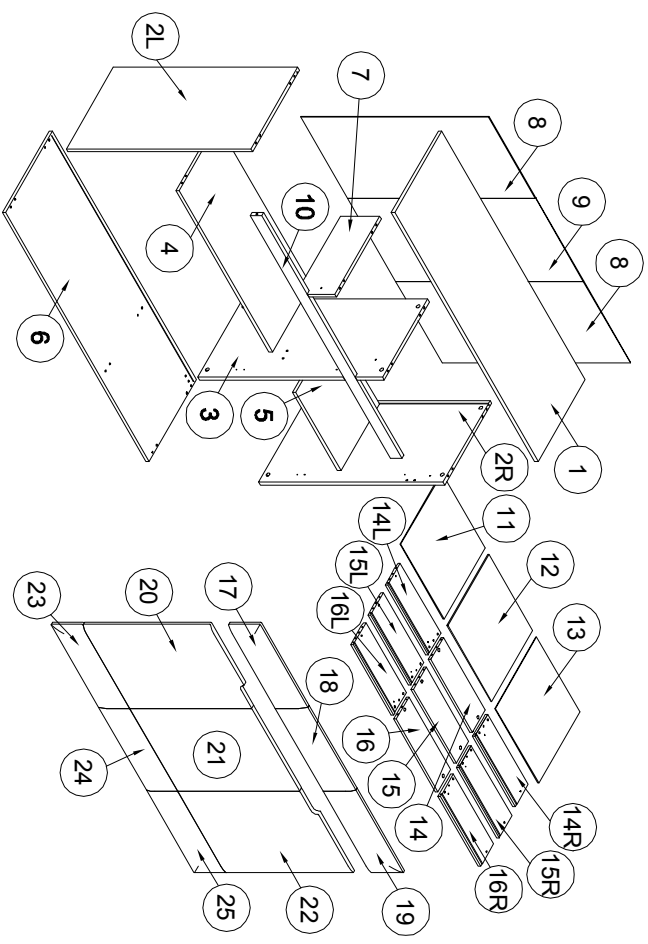

N 3x20 X25	ZF X1	NA 4x13 X12	HA M4x20 X6	H 6.3x13 X12	ZB X4	F2 X6	NB 3.5x13 X18
AB 8x38 X12	A 8x32 X45	B X30	C X30	Z X30	GLUE X1	ZC X7	X X10
Y X5	PB mini X2	PC mini X4	RB mini X2	RC mini X4	S L-678mm X1		

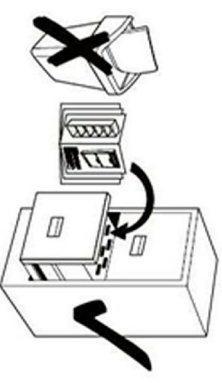
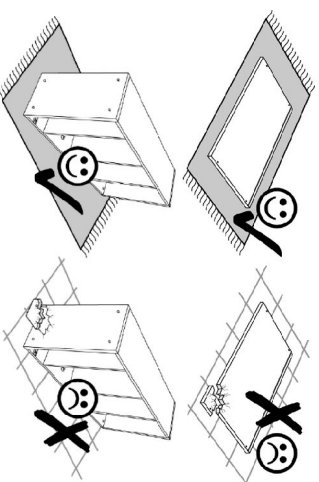

2

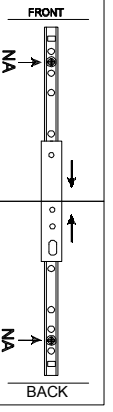
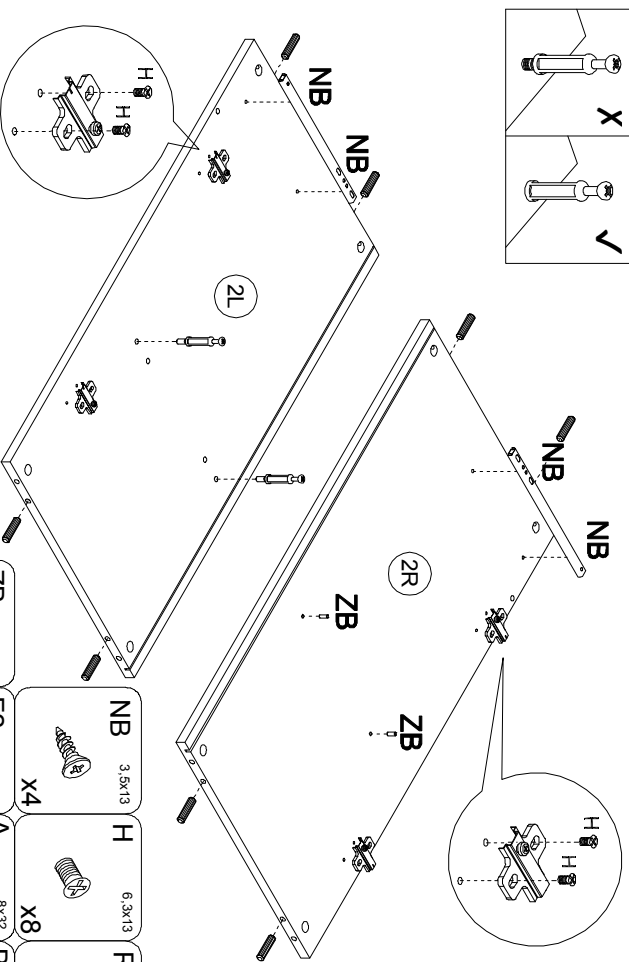
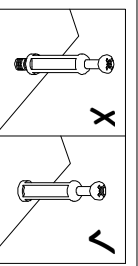

- ZB X2
- F2 X2
- NB 3.5x13 X4
- A 8x32 X8
- B X2
- H 6.3x13 X8
- RC mini X4

3

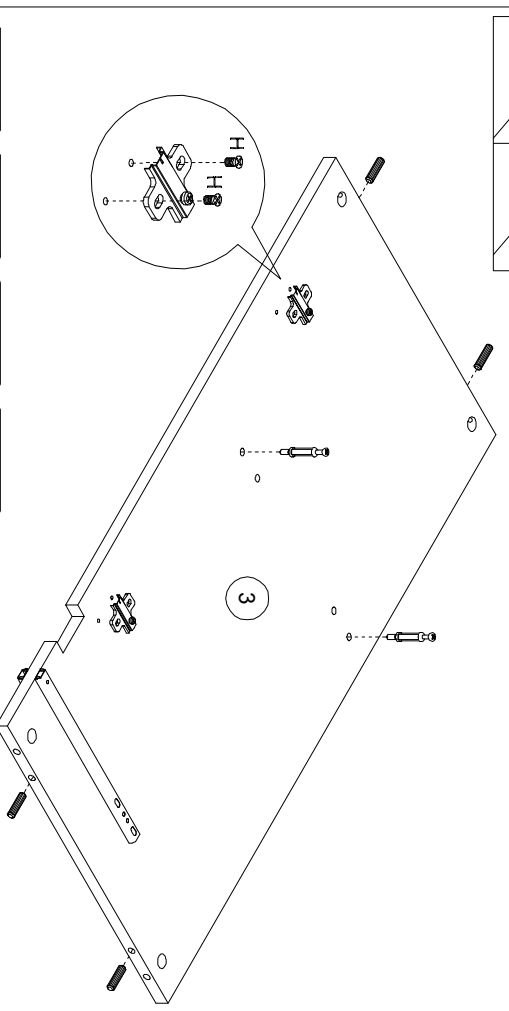
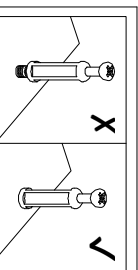

- A 8x32 X4
- B X2
- H 6.3x13 X4
- RB mini X2

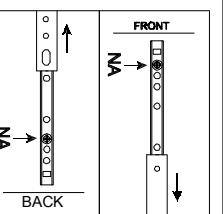
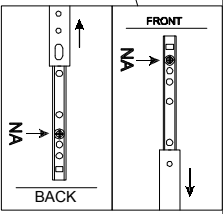
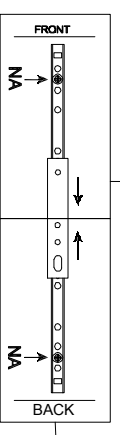
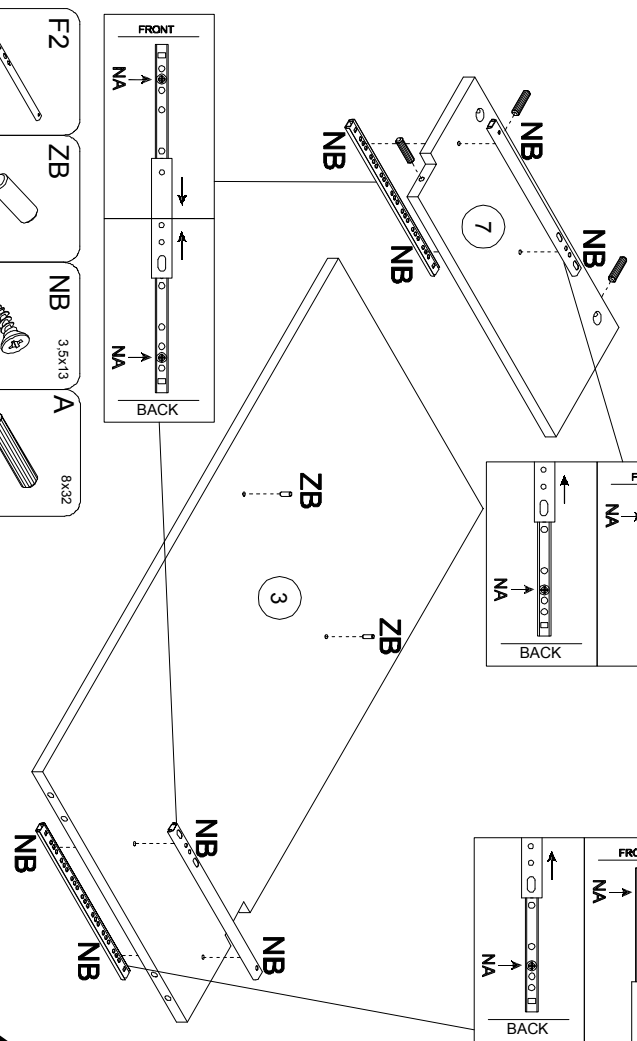
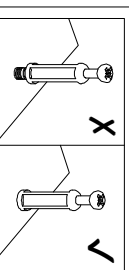

- F2 X4
- ZB X2
- NB 3.5x13 X8
- A 8x32 X3

4

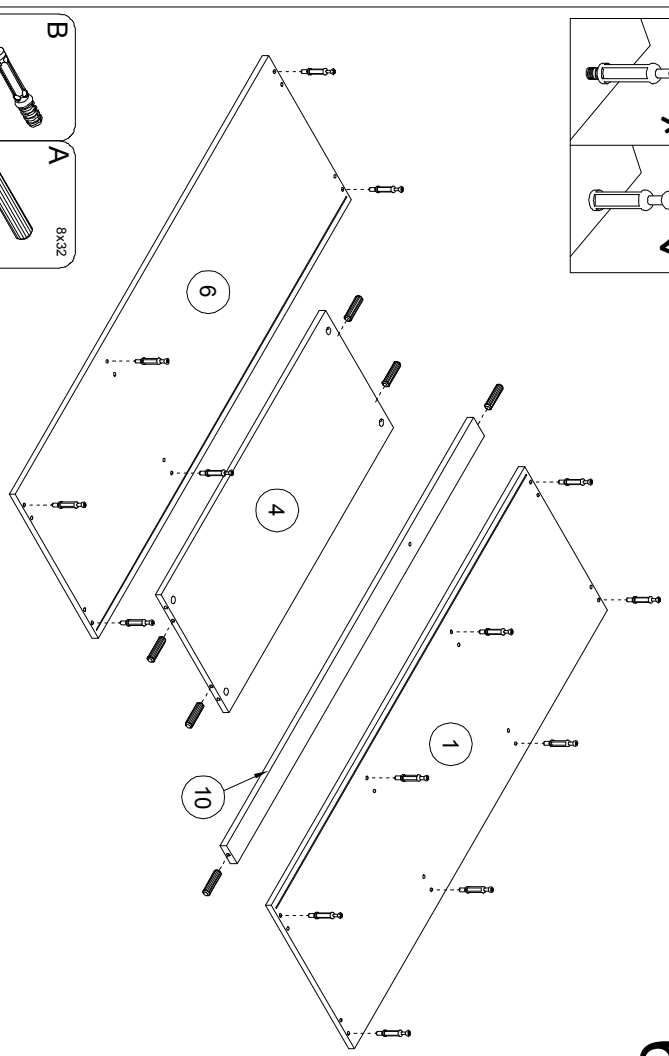
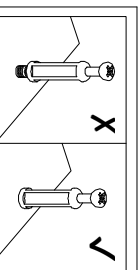

- B X14
- A 8x32 X6

5

6

- GLUE X1
- AD X12
- FD X2
- FC X4

- NA 4x13 X12

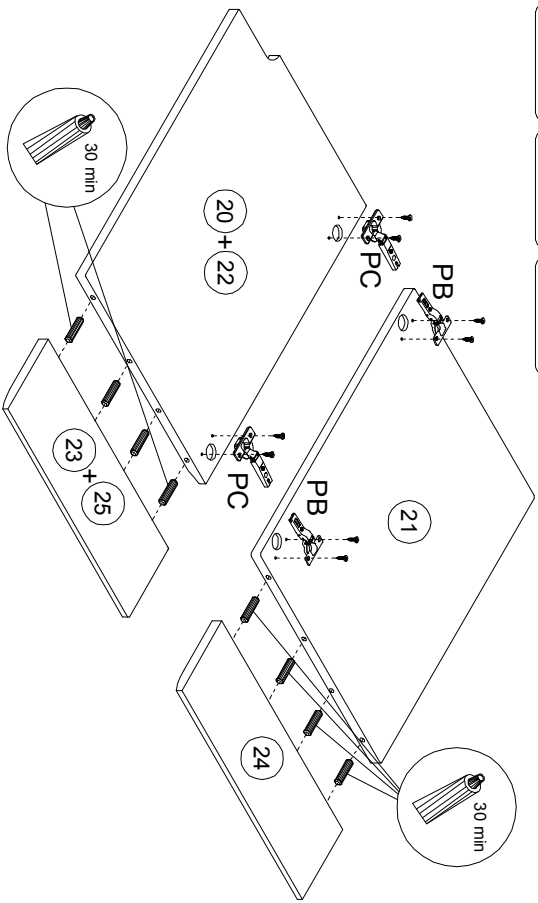

7

- 1
- 2

- C
- Z

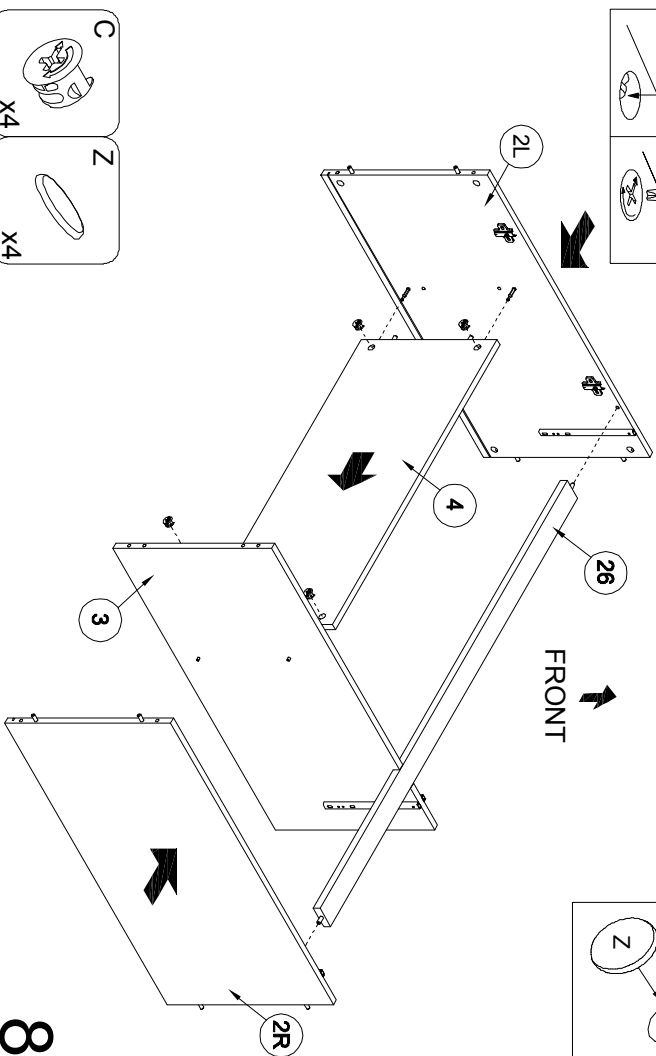

8

- 1
- 2

C

- C X6
- Z X6

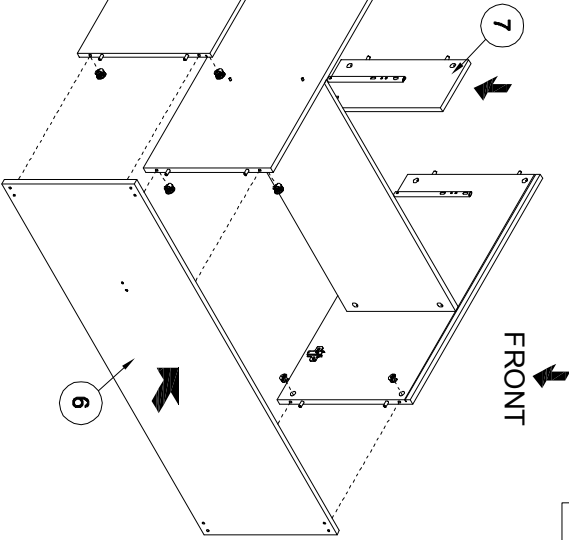

9

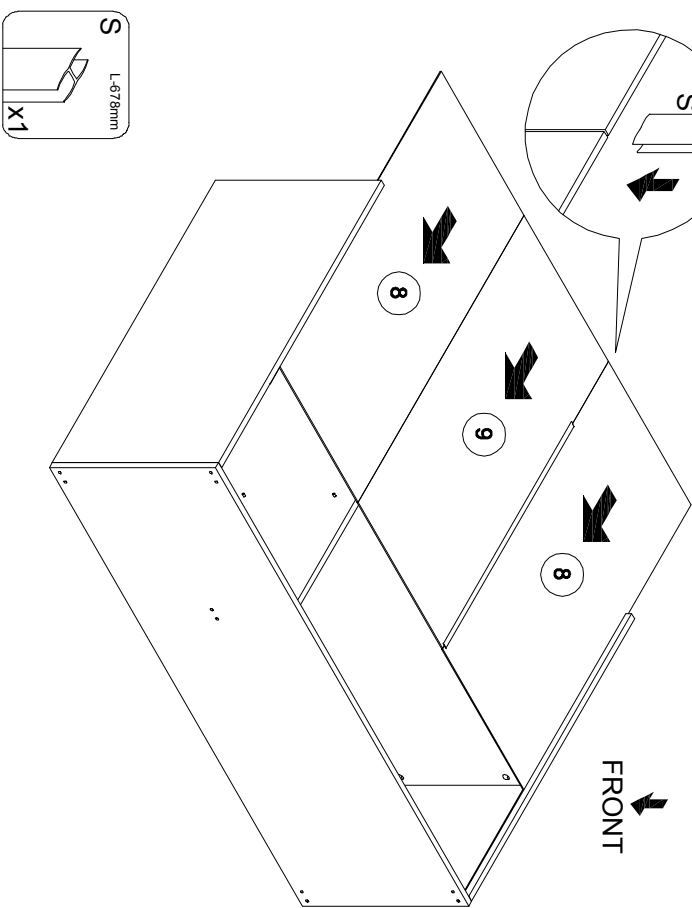
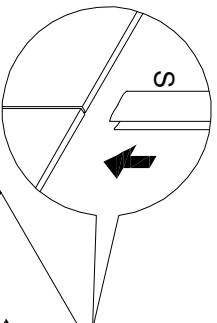

10

- S L=678mm X1

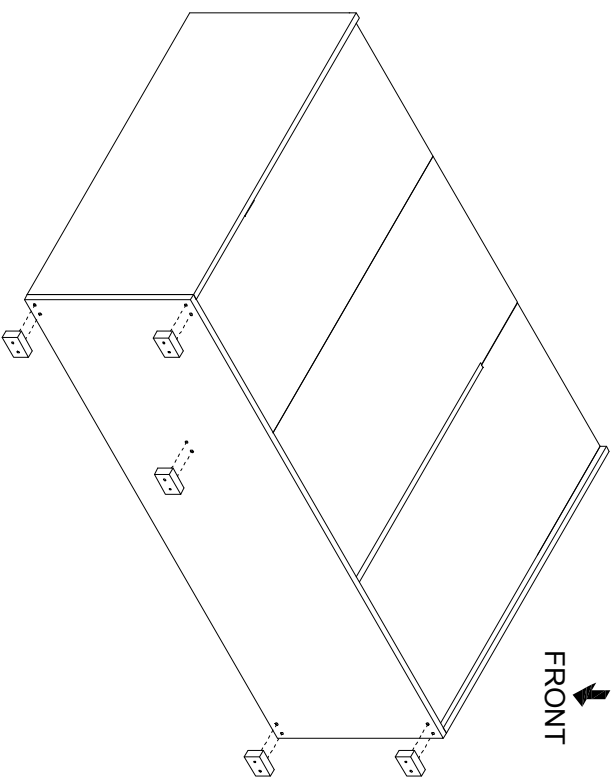

11

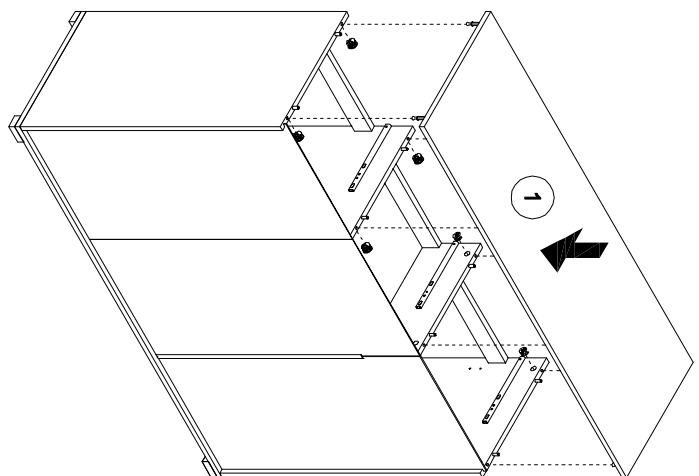
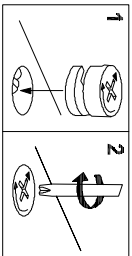

12

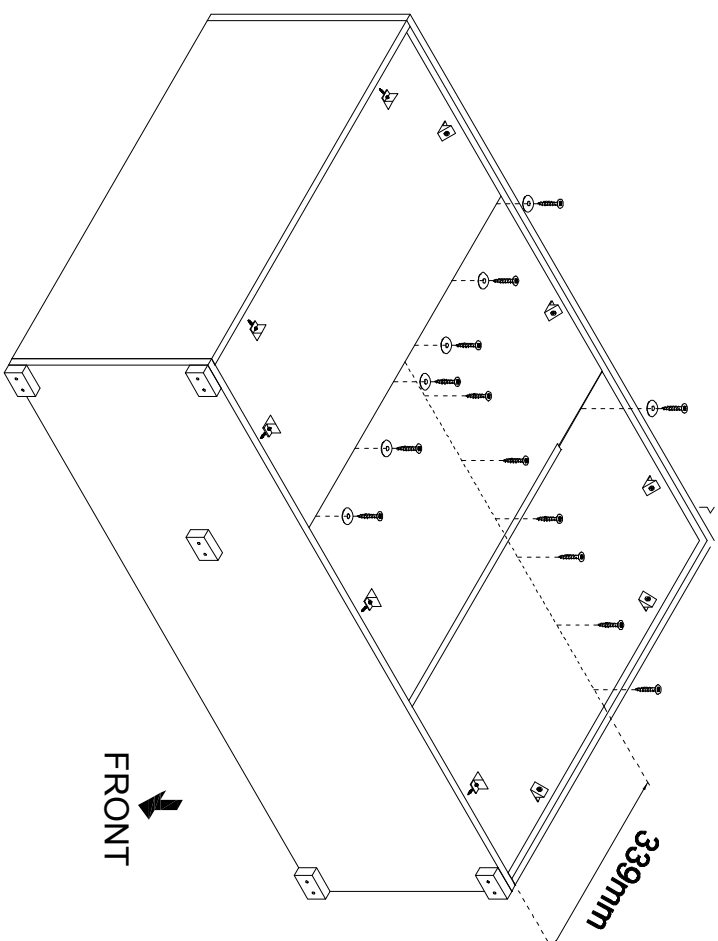
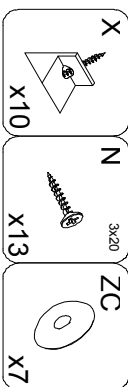
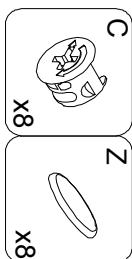

13

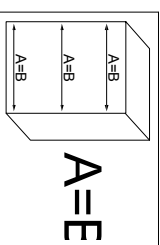

A=E

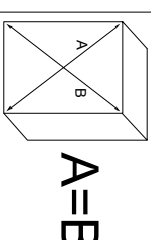

A=E

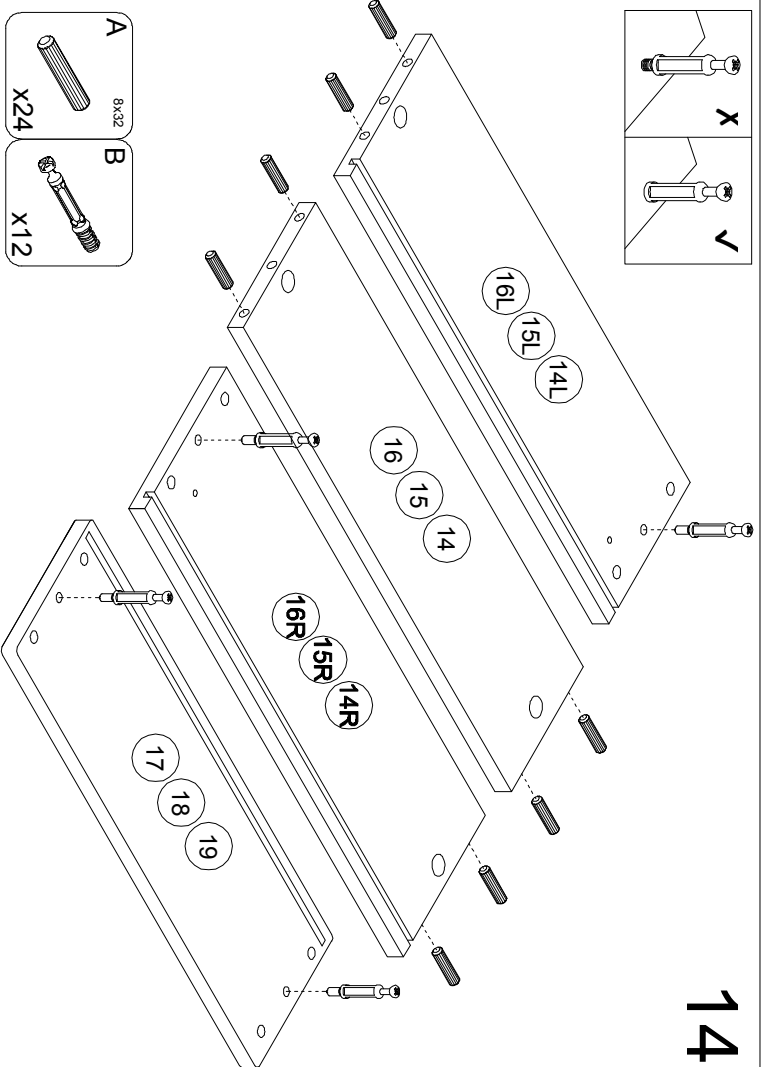
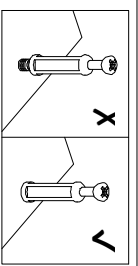

14

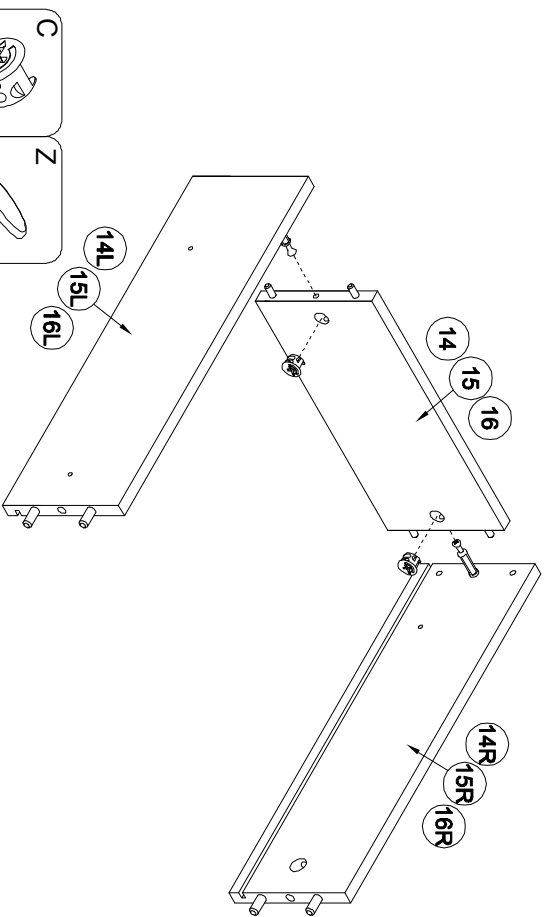
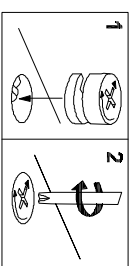

15

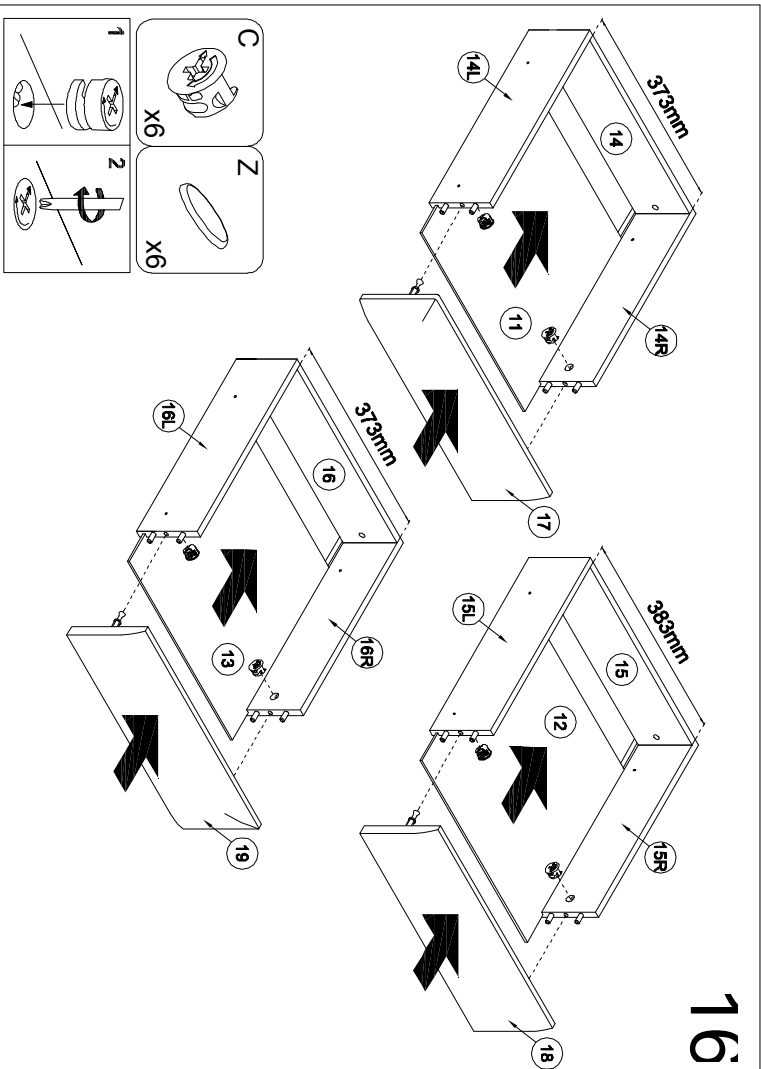

16

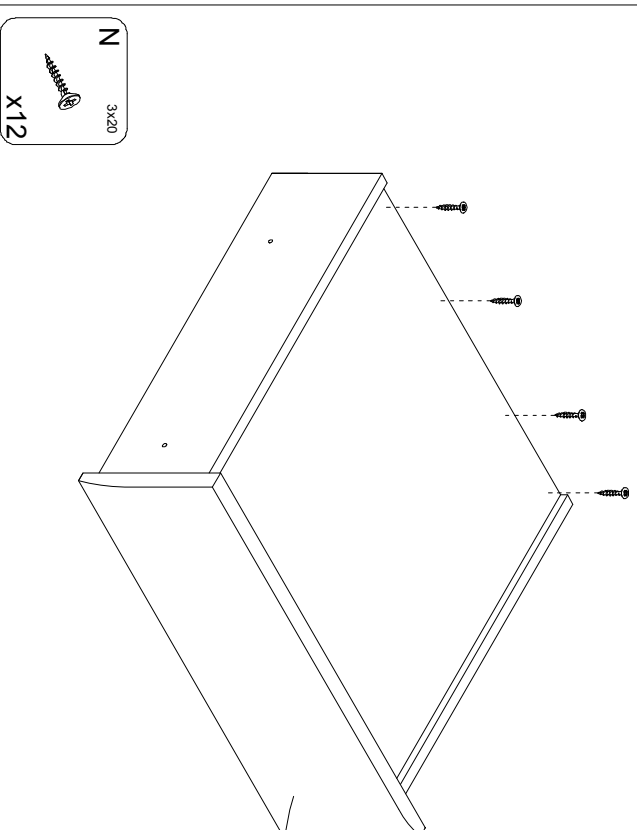
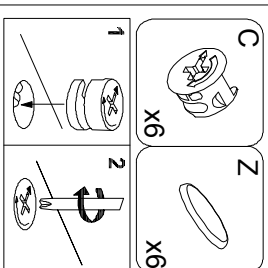

17

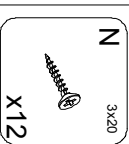
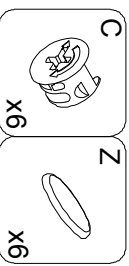

18

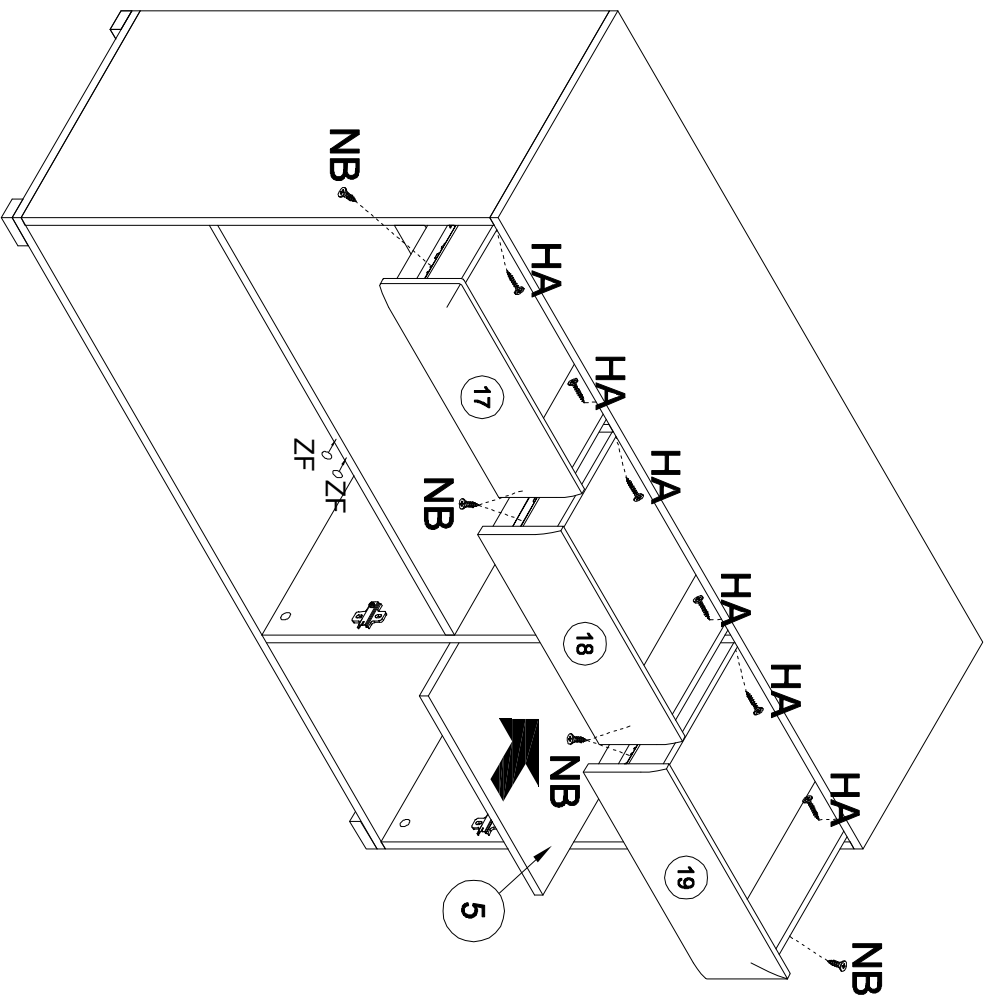

- NB 3.5x13 X6
- ZF X1
- HA M4x20 X6

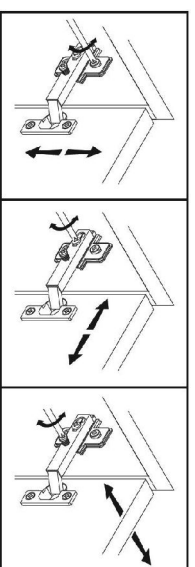

19

